

Instructions book/Warranty/KRUPPS Guarantee of Performance

# IL Caffé Bistro

Model # 867

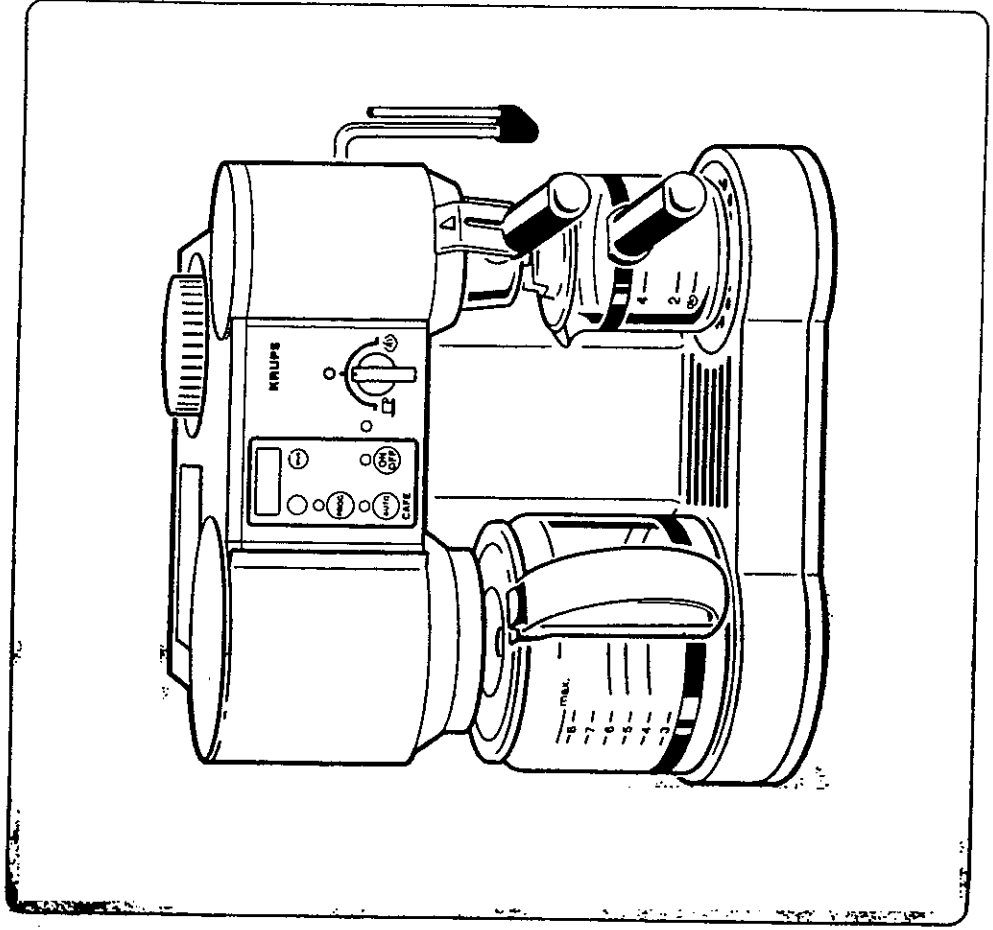

# IMPORTANT SAFEGUARDS

When using electrical appliances, basic safety precautions should always be followed, to reduce the risk of fire, electric shock, and/or injury to persons, including the following:

- Read all instructions and information in this instruction book and any other literature included in this carton referring to this product before operating or using this appliance.
- Do not touch hot surfaces. Use handles or knobs.
- To protect against electric shock, do not place cord, plugs, or appliance in water or other liquid.
- Close supervision is necessary when any appliance is used by or near children.
- Unplug from outlet when not in use and before cleaning. Allow to cool before putting on or taking off parts, and before cleaning the appliance.
- Do not operate any appliance with a damaged cord or plug or after the appliance malfunctions, or has been damaged in any manner. Return appliance to an authorized service facility for examination, repair or adjustment.
- The use of an accessory not evaluated for use with this appliance may cause injuries.
- Do not use outdoors.
- Do not let cord hang over edge of table or counter, or touch hot surfaces.
- Do not place on or near a hot gas or electric burner, or in a heated oven.
- To disconnect, turn any control to "OFF", then remove plug from wall outlet.
- Do not use appliance for other than intended use.
- Do not unscrew or remove boiler cap while the machine is in operation. Wait until brewing cycle is completed and all water and steam has been used up.
- Appliances with Glass Containers.
  - A. The container is designed for use with this appliance. It must never be used on a range top.
  - B. Do not set a hot container on a wet or cold surface.
  - C. Do not use a cracked container or a container having a loose or weakened handle.
  - D. Do not clean container with cleansers, steel wool pads, or other abrasive material.

# SAVE THESE INSTRUCTIONS

## SPECIAL CORD SET INSTRUCTIONS

Regarding your Cord Set:

- A. A short power-supply cord is to be provided to reduce risks resulting from becoming entangled in or tripping over a longer cord.
- B. Longer extension cords are available and may be used if care is exercised in their use.
- C. If a long extension cord is used, (1) the marked electrical rating of the extension cord should be at least as great as the electrical rating of the appliance, (2) if the appliance is of the grounded type the extension cord should be a grounding type 3-wire cord, and (3) the longer cord should be arranged so that it will not drape over the counter top or table top where it can be pulled on by children or tripped over.
- D. This appliance has a polarized plug (one blade is wider than the other). As a safety feature, this plug will fit in a polarized outlet only one way. If the plug does not fit fully in the outlet, reverse the plug. If it still does not fit, contact a qualified electrician. Do not attempt to defeat this safety feature.

## WARNING

To reduce the risk of fire or electric shock, do not remove the base. No user serviceable parts inside. Repair should be done by authorized service personnel only.

## CAUTION

This appliance is for household use. Any servicing other than cleaning and user maintenance should be performed by an authorized service representative. Do not immerse this coffeemaker in water or any other liquid.

- Check voltage to be sure that the voltage indicated on the name plate agrees with your voltage.
- Never use warm or hot water to fill the water container! Use cold water only!
- Never refill the water chamber while this coffeemaker is in the "on-position". Turn the coffeemaker off and let it cool down for ten minutes before refilling with water.
- Do not place carafe on a hot surface or in a heated oven.
- Before turning your KRUPS coffeemaker on, please make sure that carafe sits flat on inside circle of heating plate.
- Never remove carafe before brewing is completely finished (this is the case when dripping from the filter holder into the carafe has stopped completely).
- Keep your hands and the cord away from hot parts of the appliance during operation.
- Never clean with scouring powders or hard implements.

# Espresso/Cappuccino

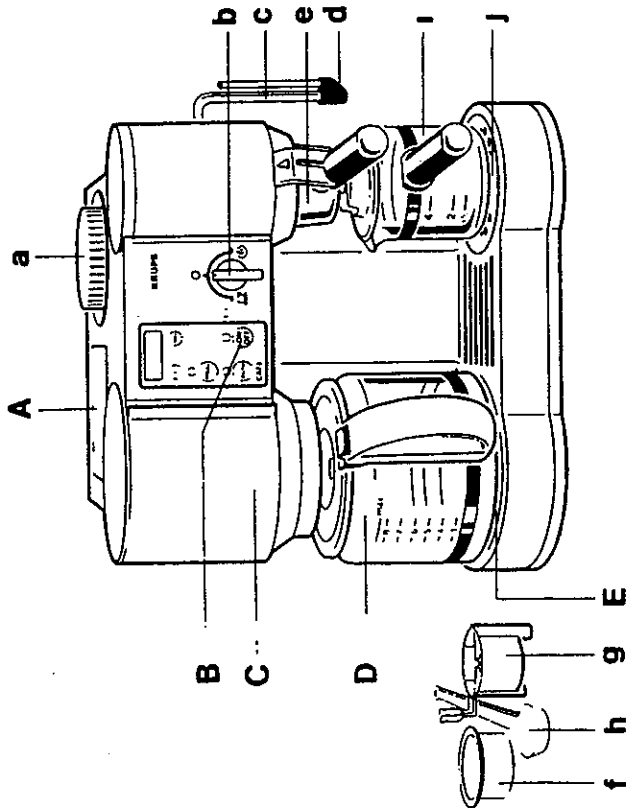
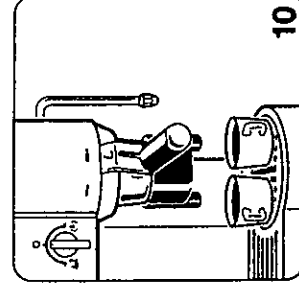
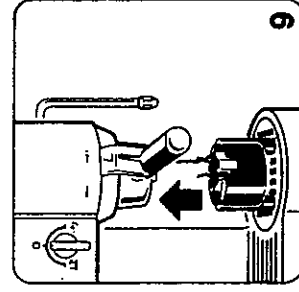
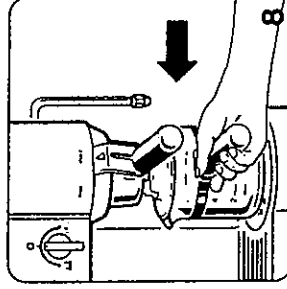
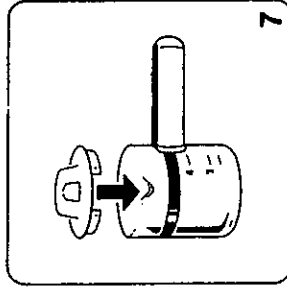
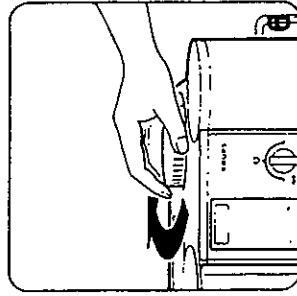
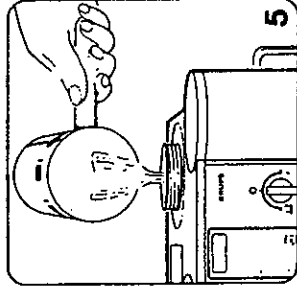
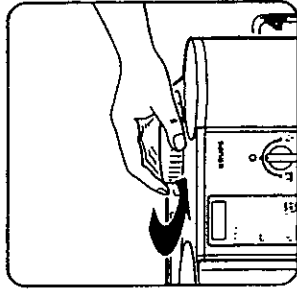
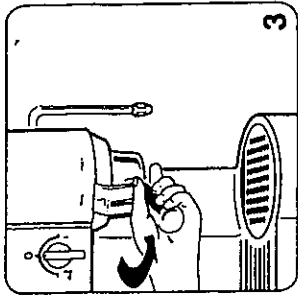
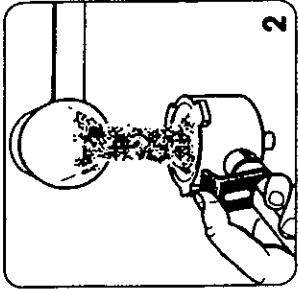
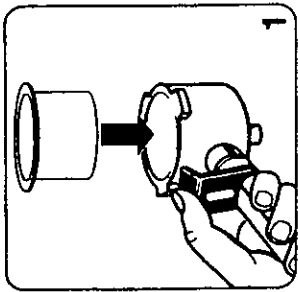

### Espresso/Cappuccino

- a - Hinged Water Chamber Lid
- B - On/Off Button
- C - Swing Filter Holder
- D - Glass Carafe
- E - Thermostatically Controlled Warming Plate

### Coffee

- a - Perfect Froth Attachment
- f - Filter Holder
- g - Filter Basket
- h - Cup Adapter
- i - Measuring Spoon
- j - Glass Carafe with Handle and Lid
- k - Removable Overflow Grid

Coffee

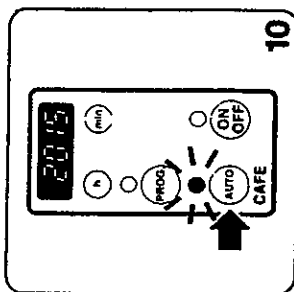
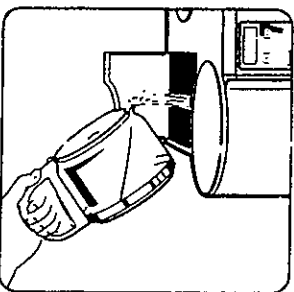
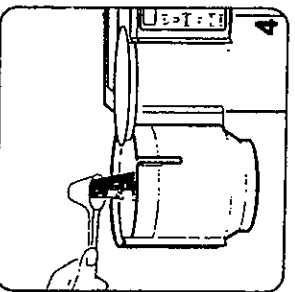
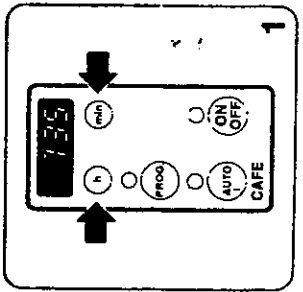
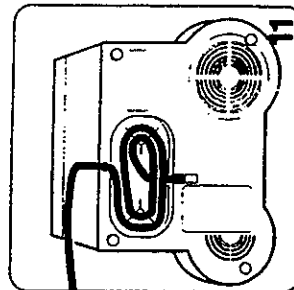
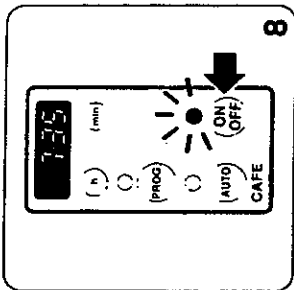
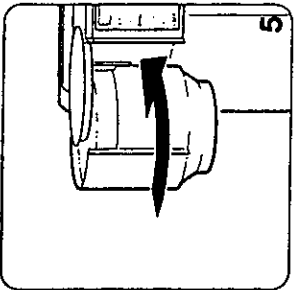
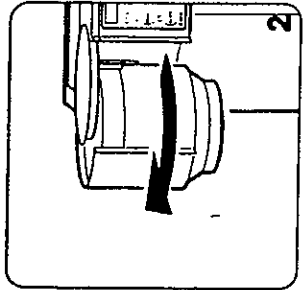
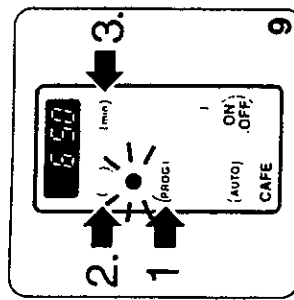
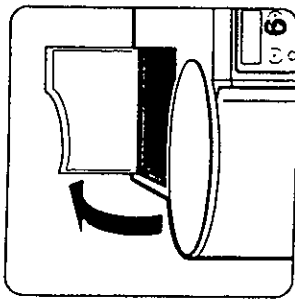
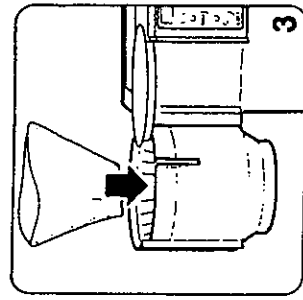

Espresso/Cappuccino

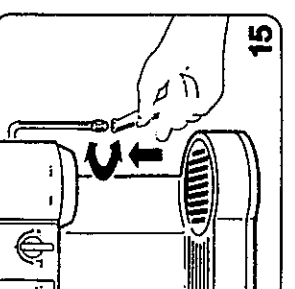
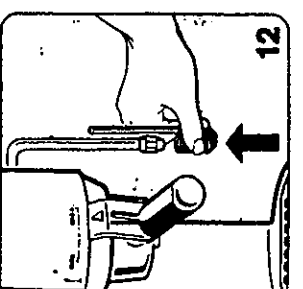
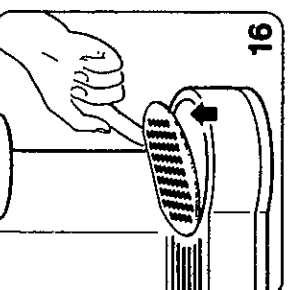
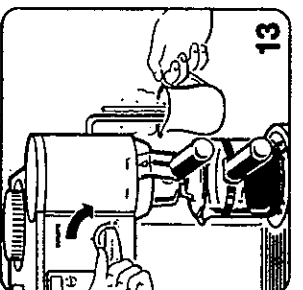
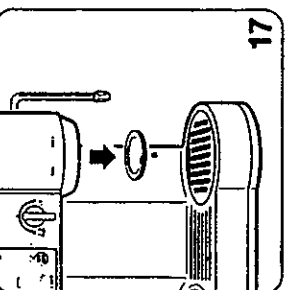
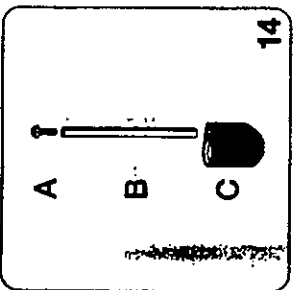

### The KRUPS IL Caffé Bistro

is a state of the art programmable combination coffee, espresso, and cappuccino maker that incorporates all of these functions in an all in one space saving coffee/espresso making system. This appliance also features an electronic programming panel which offers ease of operation and flawless performance and can be programmed for wake-up coffee up to 24 hours in advance.

### BEFORE YOU START...

We recommend that you get familiar with all the parts of your "IL Caffé Bistro" before operating the machine. With the unit unplugged, begin by inserting the filter basket (f) into the filter holder (e), fit the filter holder (e) into the brewing head, and remove and replace the boiler cap (a). Turn the selector switch (b) to the three different positions, and check out all parts of the coffeemaker as well. Wash all loose parts in warm, soapy water, rinse thoroughly and dry.

It is also recommended that you operate your "IL Caffé Bistro" once without coffee using the instruction provided for espresso and coffee making.

### CAUTION - PRESSURE

It is important to remember to NEVER open the boiler cap (a) or remove the filter holder (e) while your "IL Caffé Bistro" is turned "On" or as long as there is pressure in the boiler.

Please follow the instructions listed below to see if the machine is still under pressure. These safety precautions should be followed while your machine is in use and ten to fifteen minutes after last use of the machine.

1. Turn the selector switch to the "0" position.
2. Unplug the machine.
3. Hold a pitcher with cold water underneath the steam nozzle and insert nozzle into the pitcher.
4. Once the steam nozzle is immersed in the pitcher of water, turn the selector switch to the ☞ position. Continue this procedure until no more steam comes out of the steam nozzle.
5. Turn the selector switch to the "0" position.
6. Now you can remove the boiler cap and filter holder.

In case there is still water in the boiler chamber, remove the glass carafe, drip tray, and turn the machine upside down to empty any remaining water in the chamber.

### GENUINE ESPRESSO

Espresso is a far richer and stronger brew than regular coffee. It should be deep, dark, and delicious. Most people find that they enjoy it in small quantities because of its richness, and for that reason, espresso is usually served in small (2-2½ oz.) demitasse cups.

The mark of real espresso is its wonderful inviting fragrance and its rich frothed topping, a light brown "crema". Your "IL Caffé Bistro" properly used, will always produce espresso that is deep, dark, and delicious. Just follow the instructions and use fresh, well-roasted, pre-ground espresso or espresso beans you grind yourself.

**Grinding Espresso Beans**  
If you use the KRUPS "Fast Touch" (model # 203), or "Touch Top" (model # 208) coffee mills, the grinding time for 4 cups of espresso is approximately 16-18 seconds.

Remember: Espresso requires a fine grind.

### Making Espresso

1. Place your "IL Caffé Bistro" near an electrical outlet, then plug in the machine.  
Make sure the selector switch (b) is in the "0" (off) position.

2. Place your filter basket (f) into the filter holder (e) (see figure 1). The basket is marked on the inside indicating 2 or 4 cups. Fill to the desired level.
3. Fill the filter basket with ground espresso coffee (see figure 2). Pack the coffee lightly and clear any excess coffee from the rim of the filter holder. This will ensure the filter holder will fit properly into the brewing head.

### ATTENTION

Do Not Pack Coffee Tightly.  
Do Not Fill More Coffee Than Indicated By The 4-Cup Marking.

This might cause clogging or overflow (see section Problems & Causes).

4. Insert filter holder (e) containing the filter basket and coffee into the brewing head. The filter holder must be inserted so that the arrow on the filter holder is in line with the beginning of the line on the machine. Press the filter holder upwards and turn firmly to the right at least to "min" (minimum) mark and at the farthest to the "max" (maximum) marking (see figure 3). The "min" and "max" markings have nothing to do

with the strength of the coffee.  
Following this procedure will prevent the filter holder, from being dislodged as pressure builds up during the brewing process.

5. Unscrew the boiler cap (a) by turning it counter clockwise (see figure 4).
6. Using the glass carafe, fill the boiler chamber with fresh, cold water (see figure 5).

### Measuring Guidelines

The glass carafe (i) has markings for 2 cups and 4 cups and steaming.  
2 cups of water yields 2 cups of espresso.  
3 cups of water yields 2 cups espresso, plus steam for frothing milk for cappuccino.  
4 cups of water yields 4 cups espresso.  
5-5½ cups of water yields 4 cups of espresso, plus steam for frothing milk for cappuccino. 5-5½ cups of water is the upper rim of the metal band surrounding the carafe.

### CAUTION

Never fill the boiler chamber while your "IL Caffé Bistro" is in the ☞ or ☞ position.

It should be in the "0" (off) position.  
Never pour more than 12 oz. of water into the boiler chamber.

7. Place the boiler cap (a) on the machine and turn it clockwise until it is secure (see figure 6).
8. Next, place the carafe lid on the carafe (f) so that the opening points towards the pouring spout on the carafe (see figure 7).

9. Position the carafe under the filter holder. Make sure that the nozzle in the filter holder points through the opening of the carafe lid (see figure 8).

### ATTENTION

Make sure that the overflow grid (j) is in place.

10. To make espresso directly into the cups, clip the cup adapter (g) onto the filter holder (see figure 9). Place cups directly under the two spouts (see figure 10).

11. Now you are ready to make espresso. Simply turn the selector switch to the left ☞ (see figure 11). The on/off indicator light will illuminate.
12. After approximately 2 minutes the water will

have reached the proper temperature. The water at this time will pass through the ground coffee, producing espresso in the glass carafe or in the cups, whichever you choose.

13. Once the espresso has stopped brewing, turn "off" the machine by moving the switch to the "0" position. The control light will go out, indicating that the machine is off.

14. Before you remove the filter holder for cleaning, make sure that the boiler is no longer under pressure (see section CAUTION - PRESSURE).

under pressure (see section CAUTION - PRESSURE).

Remove filter holder (e). Empty filter basket (f). Repeat steps 1-4 of this section.

### CAPPUCINO

Cappuccino reportedly takes its name from the chocolate hues of the robes worn by the Capuchin monks who favored this delicious desert coffee. While cappuccino is traditionally made up of espresso and frothed milk, it can be tailored to one's own taste with cinnamon, sugar, chocolate flakes, or even liquor. Its versatility makes cappuccino a worldwide gourmet choice.

### Preparation of Cappuccino

Note: If the Perfect Froth attachment is not in place, attach it now (see figure 12).

1. The first step in making cappuccino is to make espresso. Therefore, fill the glass carafe with the amount of water which is required to make the desired amount of espresso, plus additional water for frothing milk (see section Making Espresso).

2. Fill a small pitcher 1/2 to 3/4 full with fresh, cold milk and set aside.

3. To make espresso, turn the machine to the "☐" position. As soon as half the required amount of espresso is produced, turn the selector switch to the "0" position. At this time the boiler has created enough pressure and steam to start frothing milk. Frothing milk before finishing the espresso prevents you from running out of steam. This will happen if you froth milk towards the end of the brewing process.

4. To froth milk, take your pitcher with fresh, cold milk and insert steam nozzle with perfect froth attachment halfway into the milk. Then turn the selector switch to the "☉" position. Leave in for approximately 45-60 seconds depending on how much froth you want and the type of milk you are using.

5. After the milk is frothed, set aside and allow it to settle.

6. Turn the three way selector switch back to the "☐" position to finish making the espresso.

7. Pour the espresso into a cup which has a capacity of at least 5 ounces. Add the steamed milk to the espresso and spoon on the frothed milk. The proportion between espresso and milk is to taste; in Italy it is normally 1 part espresso to 2 parts milk plus froth.

### ATTENTION

Do not bring milk to a boil (this will happen if large bubbles start forming at the surface of the milk).

Do not let the Perfect Froth attachment touch the bottom of the pitcher as this will prevent you from frothing the milk.

### ATTENTION

The top closure of the Perfect Froth attachment (see figure 14, part A) has a very fine hole which draws air into the milk. If this tiny hole gets clogged, "Perfect Froth" will not work properly. Therefore, never immerse the top closure in milk or froth.

### CLEANING

Before cleaning, turn "off" the machine, unplug it, and allow it to cool down.

The filter holder, filter basket, carafe, carafe lid, and overflow grid can be put in the dishwasher's upper rack, away from the heating/drying element.

The machine can be wiped clean by using a damp cloth. Never immerse the body of your "IL Caffé Bistro" in water or any other liquid. Clean the brewing head with a damp cloth and remove ground coffee. If there is water left in the boiler chamber, let the machine cool down, remove all loose parts and empty through the top opening by turning upside down.

1. The machine can be wiped clean by using a damp cloth. Never immerse the body of your "IL Caffé Bistro" in water or any other liquid. Clean the brewing head with a damp cloth and remove ground coffee. If there is water left in the boiler chamber, let the machine cool down, remove all loose parts and empty through the top opening by turning upside down.

### Cleaning The Steam

**Nozzle**  
Clean the steam nozzle each time after you have immersed it in the milk, otherwise the inside of the

nozzle becomes clogged and the milk deposits on the outside harden and become difficult to remove. If clogging does occur, unscrew the tip of the steam nozzle (see figure 15). Remove all milk particles using a sewing needle and rinse under the faucet. Replace nozzle tip making sure to screw it on tightly.

Wipe off the outside of the nozzle with a wet cloth. Hold the wet cloth very close to the tip of the nozzle and turn the selector switch to the "☉" Let the steam escape into the wet cloth for one or two seconds. Any milk residue will then be flushed out. Then return to the "0" position.

### Cleaning The Perfect Froth Attachment

For a thorough cleaning of the "Perfect Froth" attachment, remove part C (see figure 14). All parts should be rinsed in warm water. If the small suction opening in part A is clogged up, it can be opened with a fine needle.

### Cleaning The Drip Tray

The overflow grid can be cleaned by removing the grid (see figure 16).

## CAUTION

DO NOT try to open or disassemble the main body of the machine.

## DECALCIFYING

Under normal conditions you do not need to decalcify your "iL Café Bistro". However, in areas where there is hard water or if used very frequently, we recommend decalcifying, especially if white deposits can be seen in boiler chamber. Decalcifier is widely available and can be purchased from KRUPS Consumer Service Department.

## How To Decalcify

Please follow the procedure listed below to decalcify your machine:

- Turn machine "off" and unplug the appliance. Allow it to cool before decalcifying.
- Remove filter holder, glass carafe, and overflow grid from the machine.
- Turn machine completely upside down. With a flat blade screw driver, remove the brewing head sieve by turning it clockwise until the sieve can be removed from the machine (see figure 17).
- Turn machine upright again and reinsert overflow grid into place.

- Dissolve the decalcifying agent into 4 cups of water. Pour this solution into the boiler container and secure the boiler cap.
- Place the glass carafe without the lid underneath the brewing head.
- Turn the machine to the  position so that the solution will pass through the water heating system into the glass carafe.
- Repeat the above process using clean, cold water to remove all the remaining solution in the machine. Clean twice if necessary.

## PROBLEMS AND CAUSES MAKING ESPRESSO OR CAPPUCCINO

(Always check if the appliance is plugged in and is in the proper "On" position).

- Problem:**
1. Espresso leaking from filter holder
- Cause:**
- Filter holder not properly inserted
  - Filter holder not pushed in far enough
  - Internal gasket is dirty and needs to be cleaned

- Gasket without elasticity, replace it with a new one
  - Coffee powder not cleaned off the edge of the filter holder
- Problem:**
2. Espresso does not come out
- Cause:**
- No water in boiler container
  - No coffee in filter holder
  - Filter clogged because coffee is ground too fine and/or pressed down too hard
- Problem:**
3. Steam does not come out of steam nozzle
- Cause:**
- No water or not enough water in the boiler chamber
  - Steam nozzle is clogged (see "Cleaning" section)
  - Perfect Froth attachment is clogged (see "Cleaning the Perfect Froth")
- Problem:**
4. Not enough froth when frothing the milk
- Cause:**
- Perfect Froth attachment touches the bottom of the pitcher

- Perfect Froth tip is clogged (see figure 14, part A). See also section "Cleaning the Perfect Froth-Attachment"
- Steam nozzle is clogged (see "Cleaning")
- Not enough water left in the boiler to steam 45-60 seconds

## USING THE COFFEE MAKER

### Setting The Digital Clock

1. Plug in the KRUPS "iL Café Bistro"
2. Make sure the machine is turned "off". The red indicator light should NOT be illuminated at this time.
3. A row of flickering figures will appear in the LED display. This is your signal to set the digital clock.
4. Press the "h" button and hold it down to advance the proper read-out time in hours. Watch the time display carefully as it advances quickly (see figure 1).
- Then press the "m" button to set the minutes.

## NOTE:

- **AM/PM Indicators:**
- When setting the digital clock or programming for "Wake-Up" coffee, AM is indicated by a

light illuminated in the upper left hand corner, PM is indicated in the lower left hand corner of the LED display.

- (If you pass by the time you wish to set, just repeat the setting procedure.)

## PREPARING COFFEE

Before making your first pot of delicious coffee, we recommend rinsing the coffee maker once or twice with water only, without ground coffee in the filter basket. This will remove any possible dust which may have settled during shipping.

Be sure that the water chamber is empty. Remove any literature, etc. if found in the water chamber.

- The lid of the glass carafe must be properly positioned during the brewing process. The front hooks have to be inside the carafe and the lid has to be pushed down so that it engages with the handle of the glass carafe.
- To release the lid push the rectangular part of the lid upwards.
- Make sure that the swivel filter is closed properly during the brewing process. When closing

the swivel filter you will feel a noticeable resistance when the handle of the swivel filter is approximately 1/2 inch away from the non-removable side piece. Push in firmly until the handle touches the side of the coffee maker.

- Caution: If the swivel filter is not pushed in properly the "Stop'N Serve" trigger can not function. This may cause hot water or hot coffee to overflow.

- The "Stop'N Serve" mechanism is opened as long as the glass carafe is inserted into the machine and sits properly on the warming plate and the swivel filter is closed properly. When brewing coffee make sure the glass carafe is in place (see Stop'N Serve section).

## Putting in The Ground Coffee

1. Swing out the swivel filter (C) (see figure 2) and insert a paper filter. We recommend using KRUPS size 4. When inserting a paper filter make sure the seam is pointing towards the handle of the filter holder (see figure 3).
- Use your hands to conform the filter to the

contours of the filter holder. This will enable you to achieve better results.

- If you prefer a more permanent filter, the KRUPS "Gold Tone" filter # 053 is available as an accessory, this can be purchased from your local retailer or call the KRUPS Consumer Service department.

2. Put ground coffee into the filter holder (see figure 4). We suggest using one level KRUPS measuring spoon of ground coffee for each cup of robust brewed coffee. After using your KRUPS coffee maker several times, you can adjust the quantity to suit your own taste.

- We do not recommend using coffee that is ground to a powder-like consistency, as this will prevent water from passing through the coffee.
3. Close the swivel filter and make sure that it is completely closed (see figure 5).

#### ATTENTION

- Make sure that the filter paper does not fold over when closing the swivel filter. Otherwise the water might run between the filter paper and the filter holder producing a very weak cup of coffee.

#### Filling The Water Chamber

1. Open the hinged water chamber lid (see figure 6). Pour in the desired quantity of water (see figure 7).
- The amount of freshly brewed coffee delivered after the brewing process will always be slightly less than the amount put into the water chamber. This is due to the minimal absorption of the water by the ground coffee. Therefore, put in a little more water to begin with so that you will have the number of cups that you desire.
2. Place the glass carafe with lid in position on the warming plate.

3. Turn "on" your "IL Caffè Bistro" using the "On/Off" button. The indicator light will illuminate indicating that the brewing process has begun (see figure 8).

#### AUTO SHUT OFF AND WARM KEEPING

The KRUPS "IL Caffè Bistro" is equipped with an automatic shut-off feature that will turn off the machine 2 hours after the brewing process has begun. After two hours the red indicator light will go out indicating that the coffee maker is "off"

#### Benefits:

- This will help prevent the coffee from losing its flavor.
- Energy saving
- Safety feature
- As long as the red indicator light above the "on/off" button is illuminated the coffee will be kept warm.
- If you want to keep your coffee hot longer, push the "on/off" button on again.

#### SETTING "WAKE-UP" TIME

This feature enables you to enjoy freshly brewed coffee at any pre-selected time within a 24 hour time period. To use this feature, follow the instructions AFTER setting the digital clock.

1. Press the program button and a green light will appear indicating that the clock is ready to be programmed. Immediately press the "h" (hour) button and then the "m" (minute) button to set the program time (see figure 9). After a few seconds the LED clock will jump back to the regular time.
- The "Wake-Up" time is now stored in the electronic memory.

If you want to check the "Wake-Up" time that has been programmed, simply press the program button and the "Wake-Up" time will be displayed for a few seconds.

- If you wish to change the "Wake-Up" time, press the program button, and proceed as described in the above mentioned paragraph.

#### Preparing "Wake-Up" Coffee

To enjoy delicious "Wake-Up" coffee that is freshly brewed and hot, set the "Wake-Up" time you desire (see Section setting Wake-Up time coffee).

- Put in the ground coffee.
- Fill the water chamber with the desired amount of water for the amount of coffee desired.
- Place carafe back on warming plate.
- Press the "Auto" button and the red light will illuminate (see figure 10).
- When the programmed time arrives, the auto light will turn "off" and the light above the "on/off" button will illuminate indicating that the brewing process has begun.
- In this mode of operation, the coffee will be kept warm for two hours.

After that time, the heating mechanism will shut-off automatically (see section Automatic Shut-Off and Warm Keeping).

#### Stop'N Serve Feature

The Stop'N Serve feature is KRUPS' answer to the impatient coffee drinker's clamor for a quick cup of coffee! This device automatically stops the flow of brewed coffee through the filter cone if the glass carafe is removed from the warming plate during the brewing cycle. You have about 20 seconds between the removal of the carafe and it being reinserted back onto the warming plate.

The Stop'N Serve device closes off the filter cone so effectively that there is virtually no coffee-drip onto the warming plate. Once the carafe is replaced, the brewing process and the flow of coffee into the carafe can be resumed.

#### CAUTION

If the coffee DOES drip onto the warming plate after the removal of the carafe, it is usually an indication that the small black seal in the filter holder is missing or defective. In this case call the KRUPS Consumer Service Department at 1-800-526-5377

or in New Jersey call (201) 767-5600 and they can assist you.

It is also possible that too much ground coffee has been placed in the filter paper. This causes the water that jets into the filter cone to overflow between the filter and the sides of the filter cone.

If this blockage and subsequent dripping does occur, put the glass carafe immediately back onto the warming plate, and allow the full brewing cycle to run its course. Do not swing out the swivel filter until the brewing process is completed.

#### POWER FAILURE BACK-UP

In case of a power surge/and or failure, an electronic device will keep all functions stored up to 6 seconds.

During such an interruption, the display panel and all the indicator lights will go out. When the power returns, the indicator lights will illuminate and the display panel will show the correct time.

If the power failure lasts more than 6 seconds, the machine will switch "off" completely. When power returns, both the clock time



and the pre-programmed time will flash. In this case, the clock time and all the instructions must be reset.

#### LEANING

Always unplug this appliance before cleaning. Clean the filter basket, carafe, and lid in a solution of warm water and mild liquid soap.

These parts can also be placed in the upper level of your dishwasher away from the heating element for safe effective cleaning.

Never use scouring agents.

Never immerse the appliance itself in water. To clean, simply wipe off with a soft, damp cloth.

Never use a cloth to clean inside of the water chamber, as this might leave fuzzy deposits in the chamber. Just rinse with cold water periodically.

#### DECALCIFYING

Although your KRUPS coffee maker has the most advanced water heating and pumping system, it will periodically need cleaning with a decalcifying agent.

● This is due to the calcium (limestone) found in drinking water.

● In some areas where the water is hard, you will need to decalcify more frequently than in areas with soft water.

● It will also depend upon how often you use your coffee maker.

#### When To Decalcify

You will know when such a cleaning is necessary by an obvious slowdown in the brewing time of your coffee. This extended time indicates that there is a calcium deposit in your coffee maker. Decalcifier is widely available and can be purchased from the KRUPS Consumer Service Department.

#### LIMITED one-year warranty

Your KRUPS product is covered by the following warranty: If, within one year from date of purchase, this KRUPS product fails to function because of defects in material or workmanship, KRUPS North America, Inc. will, at its option, repair or replace the unit without charge, provided the owner returns:

- The KRUPS product (securely packed) and
- Proof of date of purchase to: KRUPS Customer Service, KRUPS NORTH AMERICA, Inc., 7 Reuten Drive, CLOSTER, New Jersey 07624

To assure prompt service, include a letter indicating the specific cause for returning your KRUPS product.

Do not return any loose parts or any accessories which are not defective with your appliances to avoid damage and loss in transit.

This warranty will be void if malfunction was caused by damage to the product by accident, misuse, use on frequency or voltage other than marked on the product and/or described in the instructions, abuse including tampering, damage in transit, or use for commercial purposes.

This warranty gives you specific legal rights, and you may also have other rights which vary from state to state.

## KRUPS'S GUARANTEE OF PERFORMANCE

For service, repair, or warranty please see instructions below.

If you have any other questions concerning your "IL Caffé Bistro" machine # 867 call the Krups Customer Service Department toll free (Monday through Friday [except holidays] from 9 AM to 4 PM Eastern Standard (Time) 1-800-526-5377 (in New Jersey call [2 01] 7 67-5600).

This fine KRUPS product is manufactured according to a rigid code of quality standards, and, with a minimum amount of care, should give years of satisfying service. However, should the need arise for repairs or for replacement parts (within or after the warranty period), please do as follows for the most convenient, fastest service.

If your product needs to be repaired please send it to the address listed below:

KRUPS Customer Service  
KRUPS North America, Inc.  
7 Reuten Drive  
CLOSTER, New Jersey 07624

Pack up your appliance carefully to avoid damage in shipping and be sure to provide us with the following information:

A. Your name and address and type number of the appliance on the outside wrapping of the packaging.

B. Tape a brief note to the body of the machine indicating:

- How long you own it;
- Possible Problem.

**IMPORTANT: ONLY SEND THE DEFECTIVE APPLIANCE. KEEP ALL REMOVABLE PARTS AT HOME TO AVOID FURTHER DAMAGE IN TRANSPORT!**

We will repair or replace your KRUPS product without delay and send it back to you with no charge for shipping.

If you send us a receipt for the regular UPS or Parcel Post charges, we will even reimburse you for your shipping charges, within or after the warranty period.

On all repair work to be done after the warranty period, our Customer Service Department will bill you for material and labor only.

Do not return your appliance to the store. The KRUPS Guarantee of Performance program has been designed to provide you with the best possible service using genuine KRUPS parts.

All repair work and replaced parts will carry an extended 90-day-warranty.