

BRAUN

6520
6515
6510

English
Use Instructions
Guarantee
Service Centers



Type 5705
Type 5706

ultra
speed
Flex Integral

Flex Integral 6520

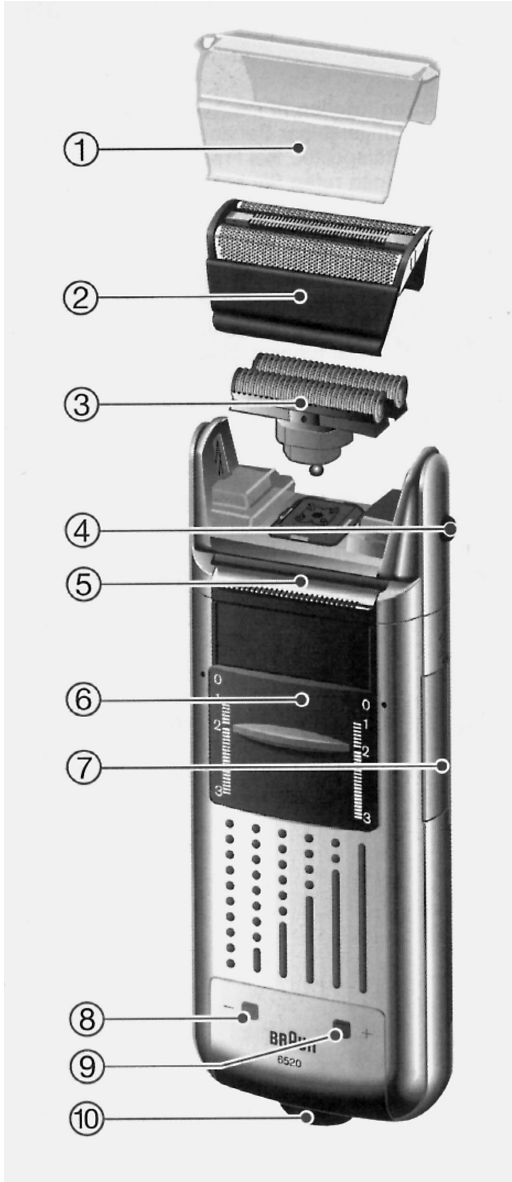

Flex Integral 6515



Flex Integral 6510



Our products are designed to meet the highest standards of quality, functionality and design. We hope you entirely enjoy your new Braun shaver.

Caution

- Do not use the shaver near, or over, basins filled with water (e. g. bath tubs, showers etc.).
- For safety reasons, periodically check the cord for damage and replace it, if it is loose in the shaver socket.

1 Description

- ① Foil protection cap
- ② Triple shaving frame
- ③ Duo cutter block
- ④ Release button
- ⑤ Long hair trimmer
- ⑥ Switch
- ⑦ Switch lock
- ⑧ Low-charge light (red) (only 6520/6515)
- ⑨ Charging light (green)
- ⑩ Shaver socket

2 Charging the shaver

- When charging the shaver for the first time, connect it to the mains and charge it for at least 4 hours (switch position «0»). Then shave without the cord until the red low-charge light starts flashing. (Modell 6510: Shave without the cord until the shaver runs distinctly slower.)
- Subsequent charges will take approximately 1 hour.
- Wattage: 6 Watts
Voltage range during charging: 12 - 240 V ≈ / 50 or 60 Hz (automatic adaption).
Best environmental temperature range for charging: 15 °C to 35 °C

English

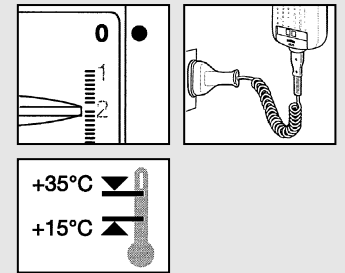
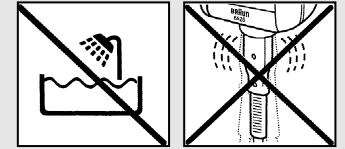

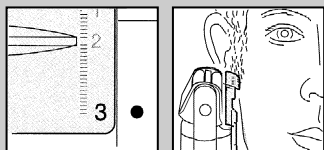
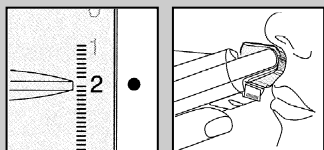
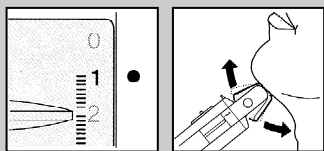
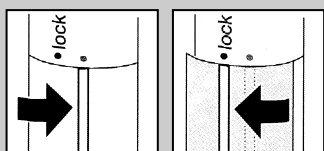
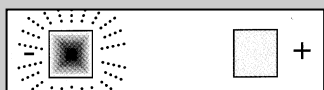
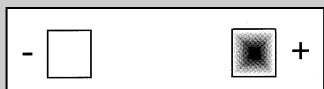

3 Pilot lights

- The green charging light indicates that the shaver is connected to the mains.

Model 6520/6515:

After the cell unit is fully charged, the charging lights starts to flash.

Model 6510:

After the cell unit is fully charged, the green charging light goes off. If later on, the charging light comes on again, this indicates that the shaver is being recharged to maintain its full capacity.

Model 6520/6515 only:

The red low-charge light flashes when the capacity has dropped below 20 %, provided the shaver is switches on. The remaining capacity will then be sufficient for 2 to 3 shaves.

4 Shaving

4.1 Switch lock

The shaver is delivered with switch lock activated (position «● lock»). Push the switch lock to position «◀» before you shave for the first time.

To avoid accidentally switching the shaver on, e. g. when travelling, push the switch lock to position «● lock».

4.2 Switch positions

0 = Off

1 = Shaving with the pivoting head.

The pivoting cutting system automatically adjusts to every contour of your face.

2 = Shaving with the pivoting head locked ad an angle (to permit shaving in difficult areas, e. g. under the nose).

3 = The long hair trimmer is activated (for trimming sideburns, moustache and beard).

4.3 Shaving with the cord

If the cell unit is discharged, you may also shave with the shaver connected to the mains (100 - 240 V ≈). (If the shaver should not run immediately, charge it with the switch on position «0» for approx. 1 minute.)

Tips for the perfect shave

- We recommend to shave before washing, as the skin tends to be slightly swollen after washing.
- Hold the shaver at right angles (90°) to the skin.
- Stretch your skin and shave against the direction of beard growth.

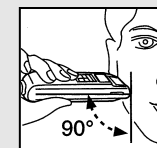

5 Keeping your shaver in top shape

5.1 Cleaning

- After shaving, switch the shaver off. Press the release button, take off the triple shaving frame and gently tap it out on a flat surface.
- Then thoroughly clean the duo cutter block with the brush as well as the inner area of the pivoting head.
- About every four weeks, clean the duo cutter block with Braun cleaning agents.

5.2 Changing the shaving parts

To maintain optimum shaving performance, you should replace the triple shaving frame or the duo cutter block, when these parts are worn.

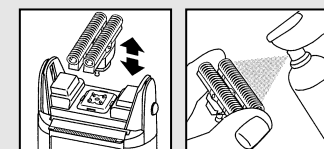
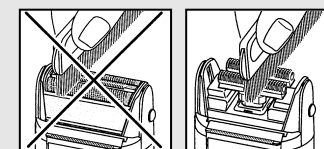
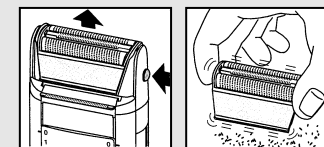

5.3 Preserving the cell unit

- In order to maintain the capacity of the cell unit, the shaver has to be discharged by shaving every 6 months approximately. Then recharge the shaver to full capacity again.
- Do not expose the shaver to temperatures of more than 50 °C for longer periods of time.

6 Accessories

(available from your dealer or at Braun Service centres)

6.1 Wall holder with charge control.

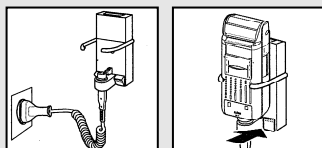

6.2 Charging cord as of 12 V

(for boat or car No. 5-001-687).
Recharging with this cord takes about 20 hours.

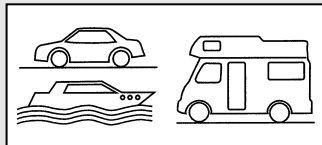

7 Environmental notice

This appliance is provided with a nickel-hydride cell unit. This cell does not contain any harmful heavy metals. Nevertheless, in the interest of recycling raw materials, please do not dispose of this appliance in the household waste at the end of its useful life. Disposal can take place at a Braun Service Centre or appropriate collection sites.

Subject to change without notice.

This product conforms to the EMC-Requirements as laid down by the Council Directive 89/336/EEC and to the Low Voltage Regulation (73/23 EEC).



Guarantee

We grant a 1 year guarantee on the product commencing on the date of purchase.

Within the guarantee period we will eliminate, free of charge, any defects in the appliance resulting from faults in material or workmanship either by repairing, or exchanging parts or exchanging the whole appliance as we may choose.

Not covered by this guarantee: damage arising from improper use (kinks in the shaving foil, breakage), normal wear on the shaving foil and defects which have a negligible effect on the value or operation of the appliance.

The guarantee becomes void if repairs are undertaken by unauthorized persons and if original Braun parts are not used.

The guarantee only comes into force if the date of purchase is confirmed by the dealer's stamp and signature on the guarantee card and registration card.

This guarantee extends to every country where this appliance is supplied by Braun or its appointed distributor and where no import restrictions or other legal regulations hinder or prevent service being given under guarantee.

Service under the guarantee does not affect the expiry date of the guarantee. The guarantee on parts or entire appliances which are exchanged ends when the guarantee on this appliance expires.

In the event of a claim under this guarantee, hand in the complete appliance with the valid guarantee card to your dealer, or send both to the nearest Braun Customer Service Centre.

All other claims including for damages resulting from this guarantee are excluded unless our liability is legally mandatory.

Those claims arising out of the sales contract with the vendor are not affected by this guarantee.

For UK only:

This guarantee in no way affects your rights under statutory law.

